



# IJF Grand Slam Rio 2009

(BRA Rio de Janeiro, 04-05 July 2009)

# -60 kg

16 Judoka

Pool A

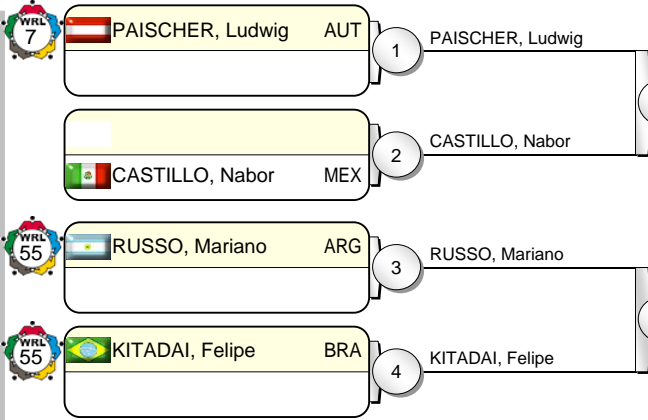

Pool B

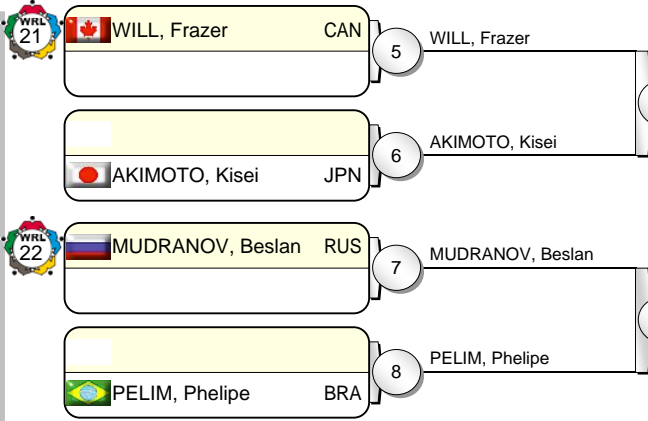

Pool C

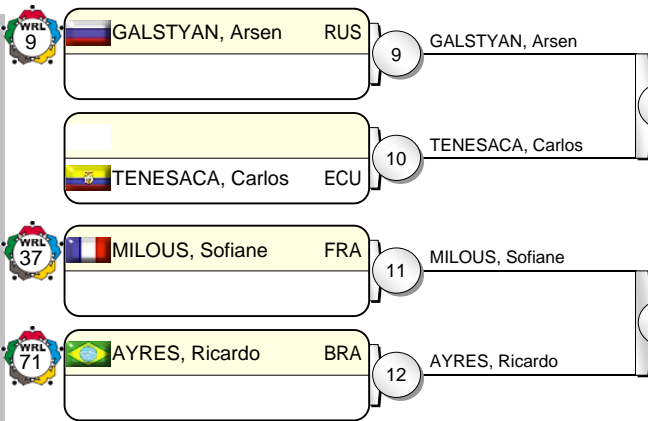

Pool D

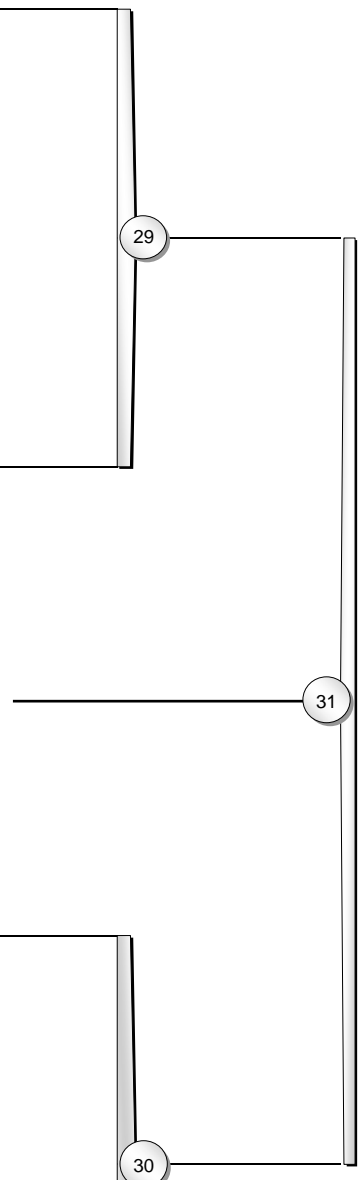
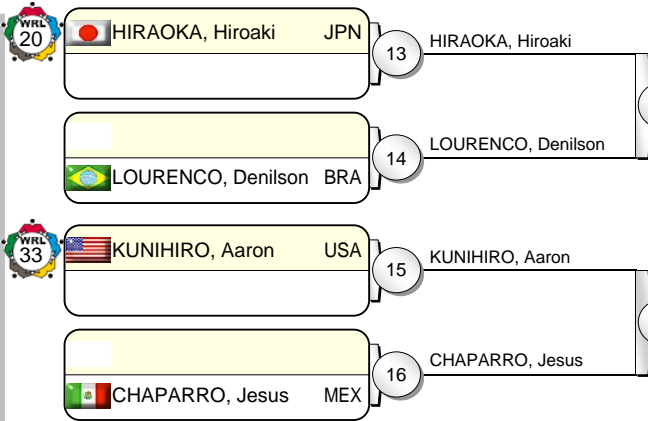

## Results

- 1.
- 2.
- 3.
- 3.
- 5.
- 5.
- 5.





# IJF Grand Slam Rio 2009

(BRA Rio de Janeiro, 04-05 July 2009)

# -66 kg

16 Judoka

Pool A

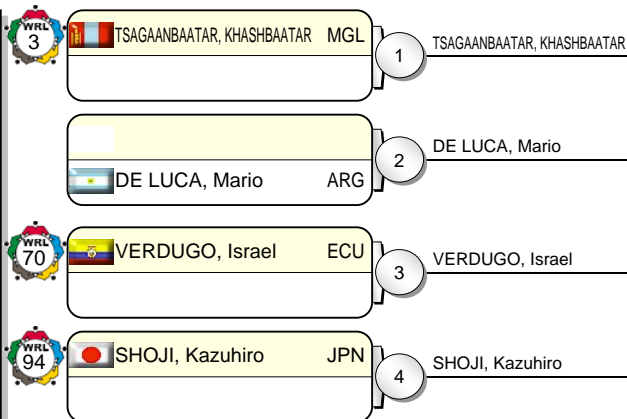

Pool B

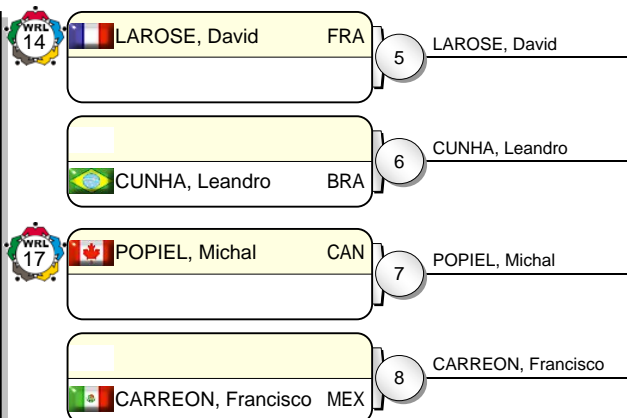

Pool C

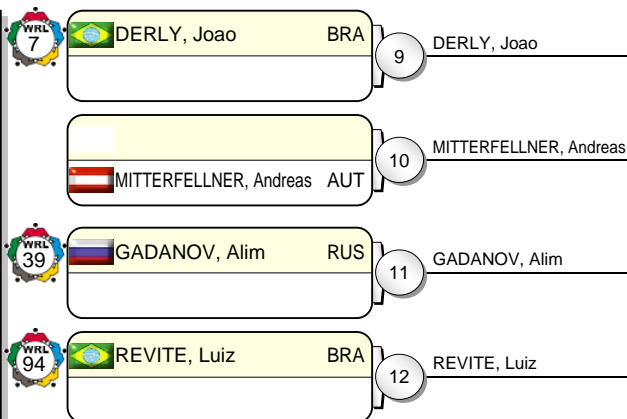

Pool D

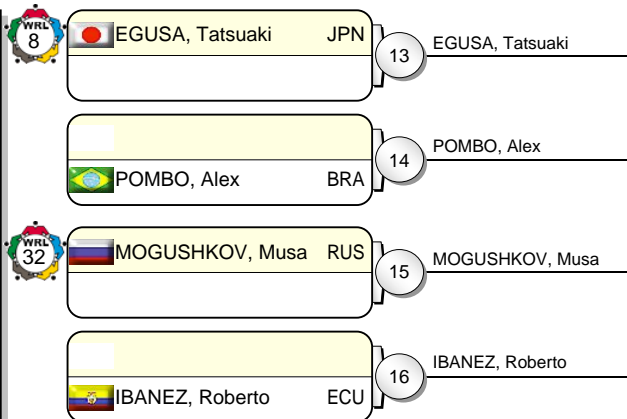

## Results

- 1.
- 2.
- 3.
- 3.
- 5.
- 5.
- 5.





# IJF Grand Slam Rio 2009

(BRA Rio de Janeiro, 04-05 July 2009)

# -73 kg

22 Judoka

Pool A

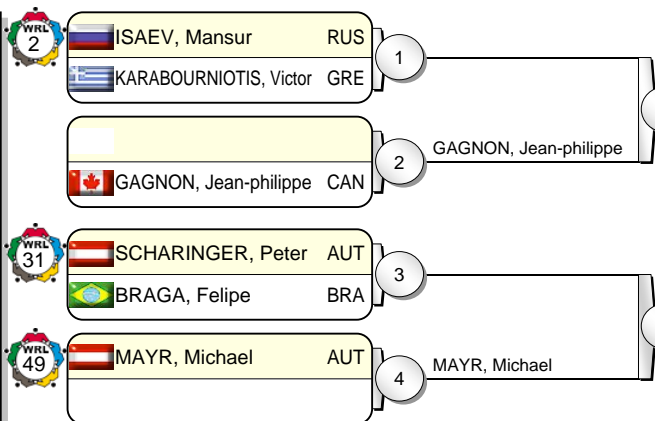

Pool B

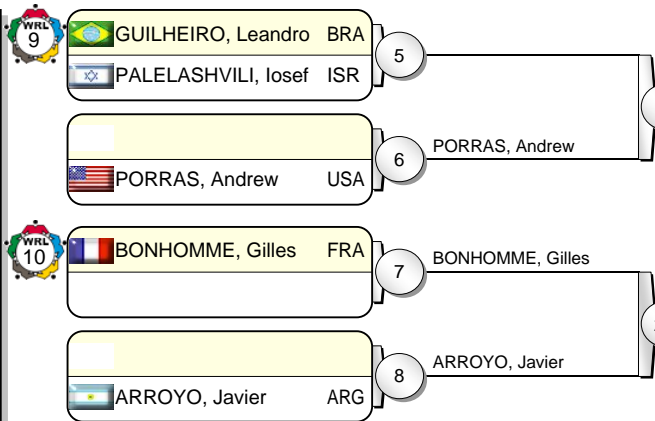

Pool C

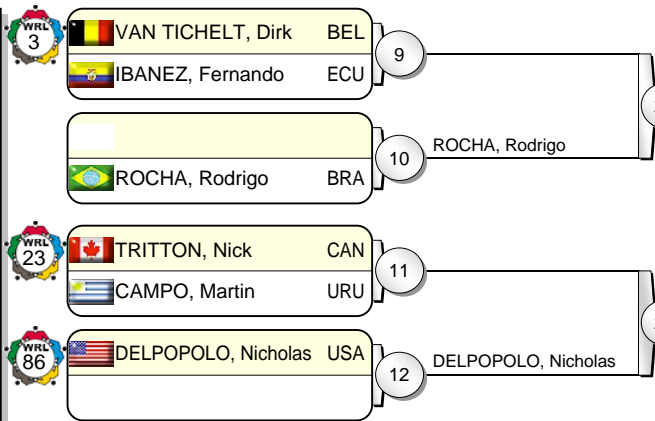

Pool D

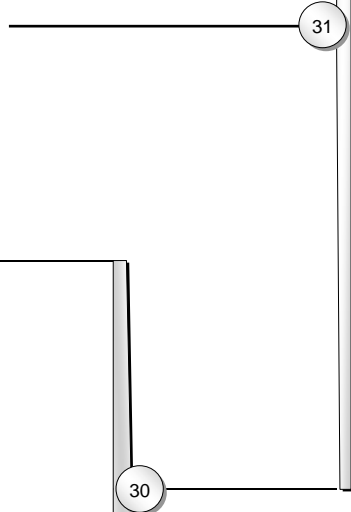
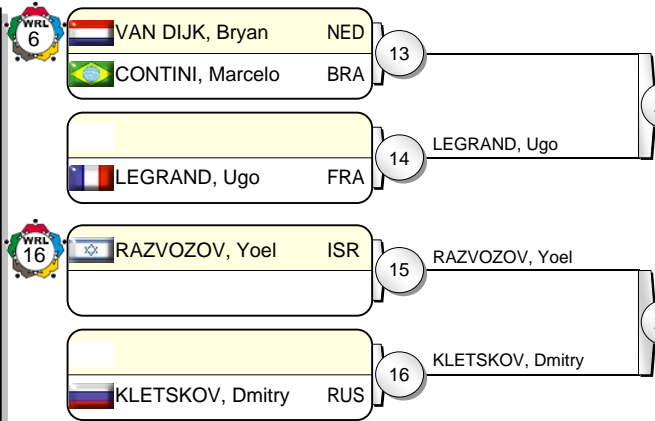

## Results

- 1.
- 2.
- 3.
- 3.
- 5.
- 5.
- 5.





# IJF Grand Slam Rio 2009

(BRA Rio de Janeiro, 04-05 July 2009)

# -81 kg

15 Judoka

Pool A

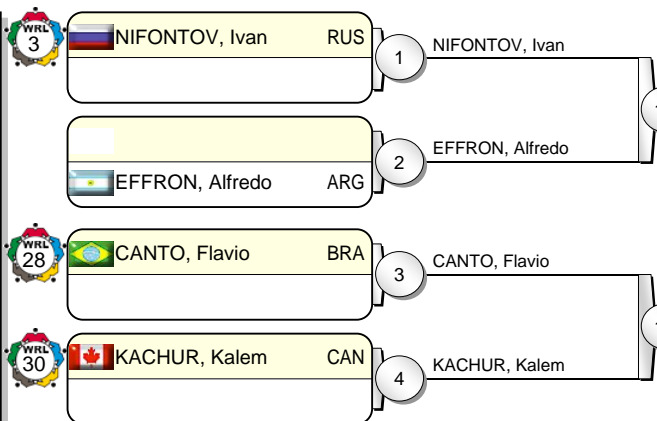

Pool B

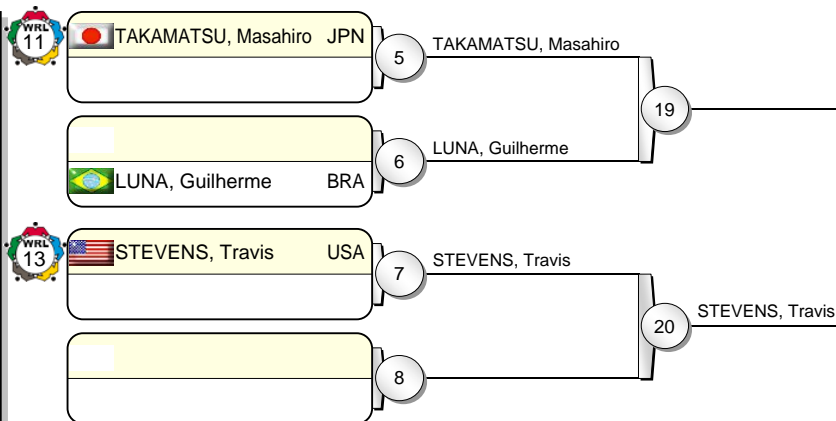

Pool C

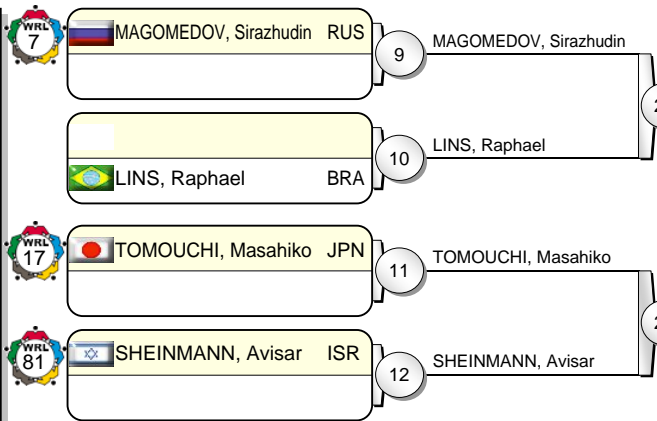

Pool D

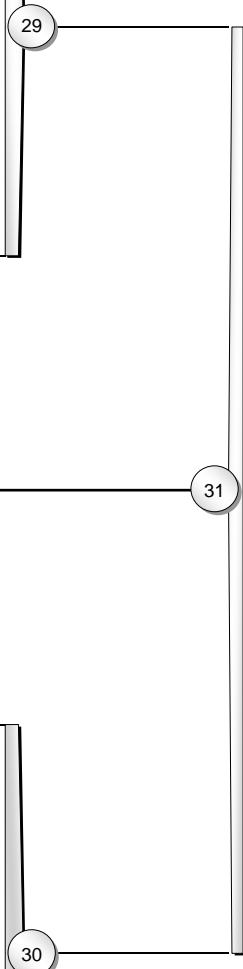
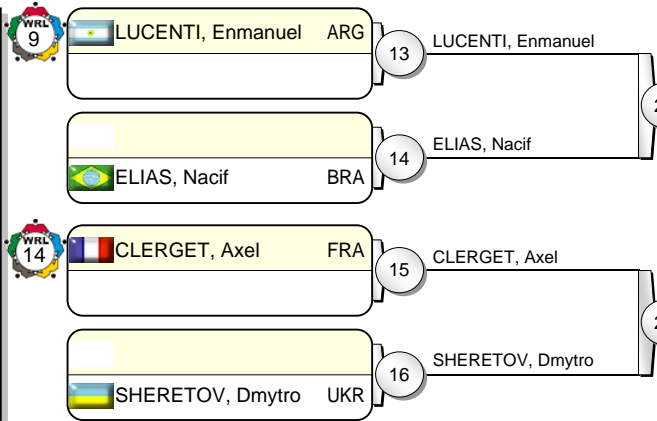

## Results

- 1.
- 2.
- 3.
- 3.
- 5.
- 5.
- 5.





# IJF Grand Slam Rio 2009

(BRA Rio de Janeiro, 04-05 July 2009)

# -90 kg

9 Judoka

Pool A

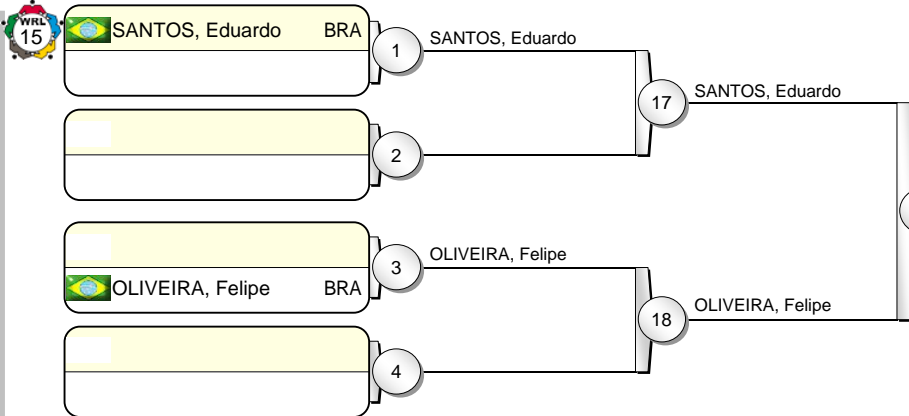

Pool B

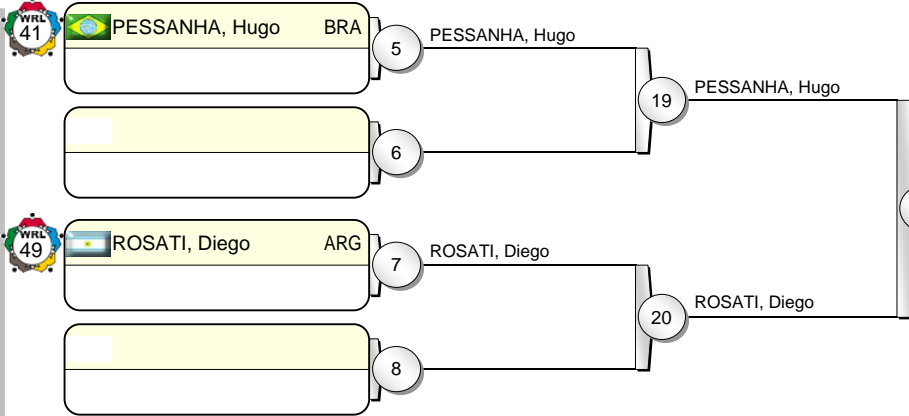

Pool C

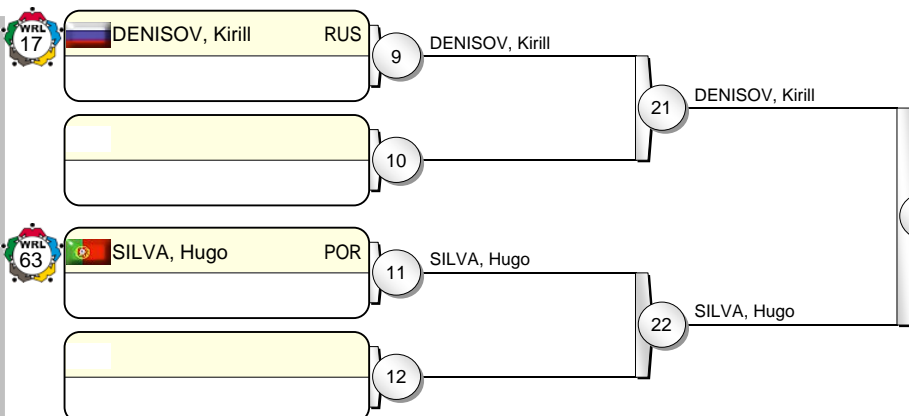

Pool D

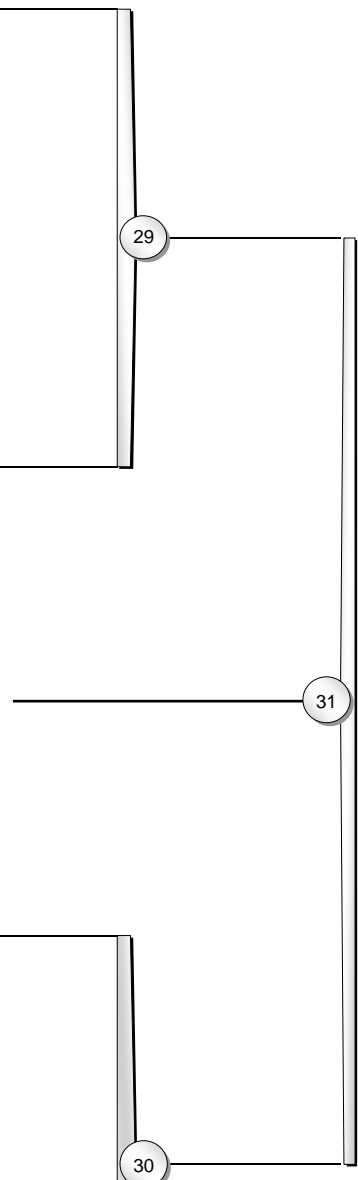
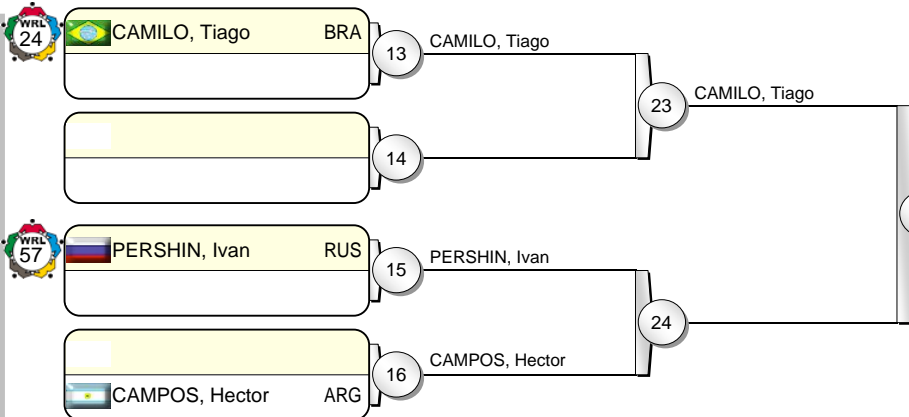

## Results

- 1.
- 2.
- 3.
- 3.
- 5.
- 5.
- 5.





# IJF Grand Slam Rio 2009

(BRA Rio de Janeiro, 04-05 July 2009)

# -100 kg

13 Judoka

Pool A

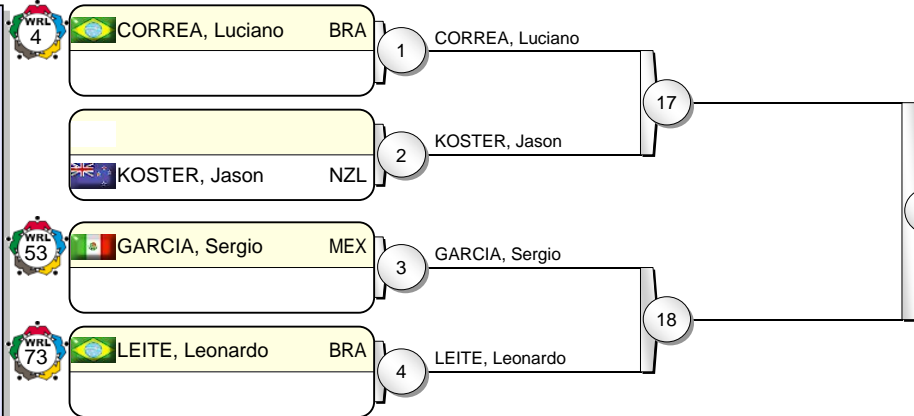

Pool B

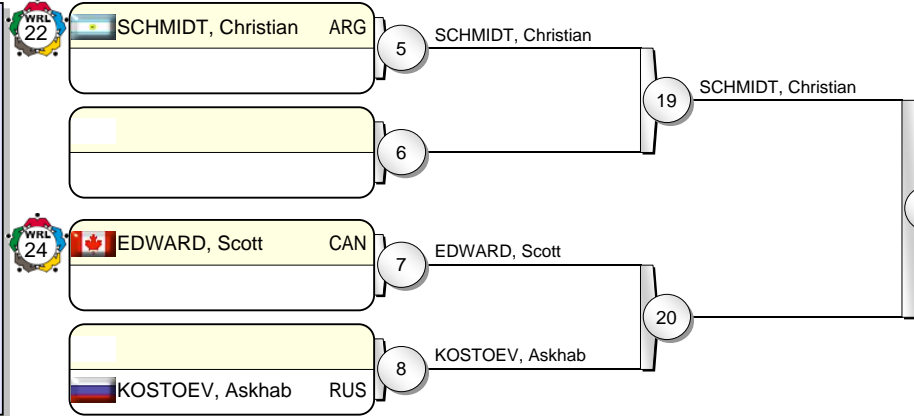

Pool C

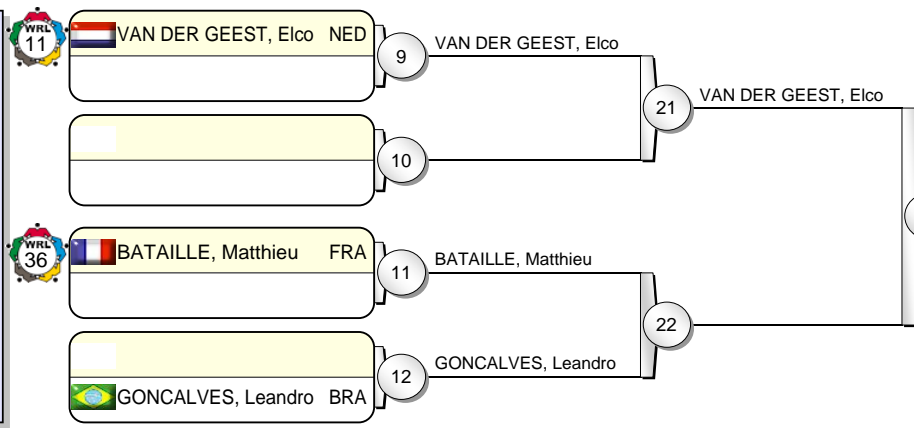

Pool D

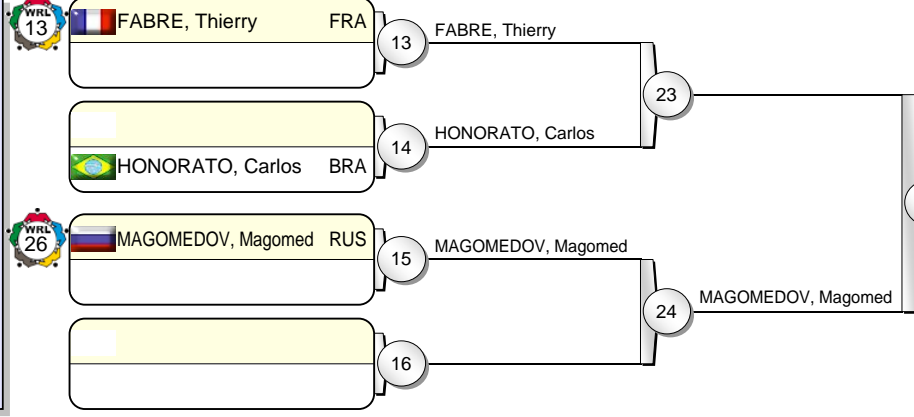

## Results

- 1.
- 2.
- 3.
- 3.
- 5.
- 5.
- 5.





# IJF Grand Slam Rio 2009

(BRA Rio de Janeiro, 04-05 July 2009)

# +100 kg

10 Judoka

Pool A

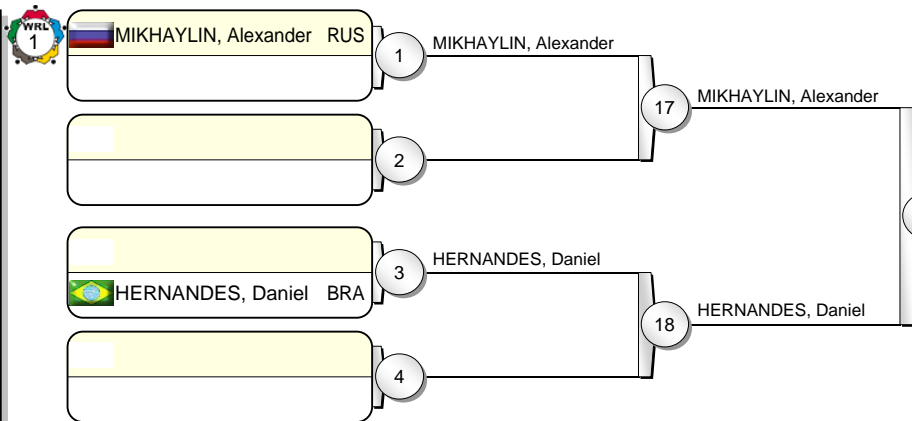

Pool B

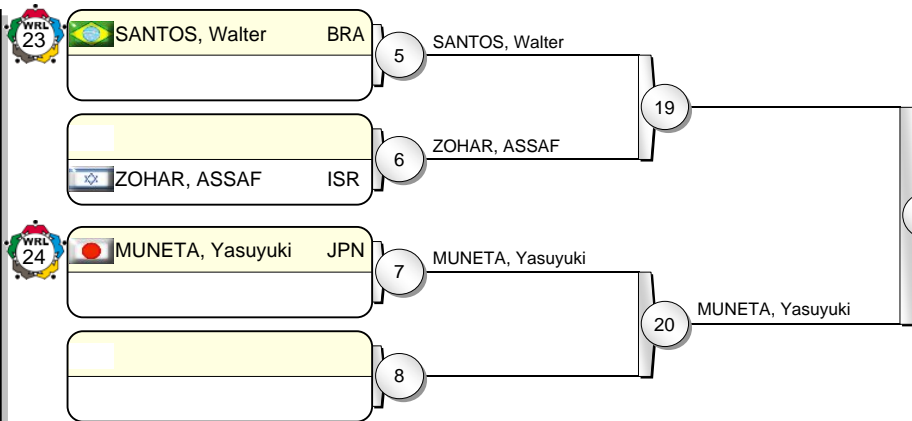

Pool C

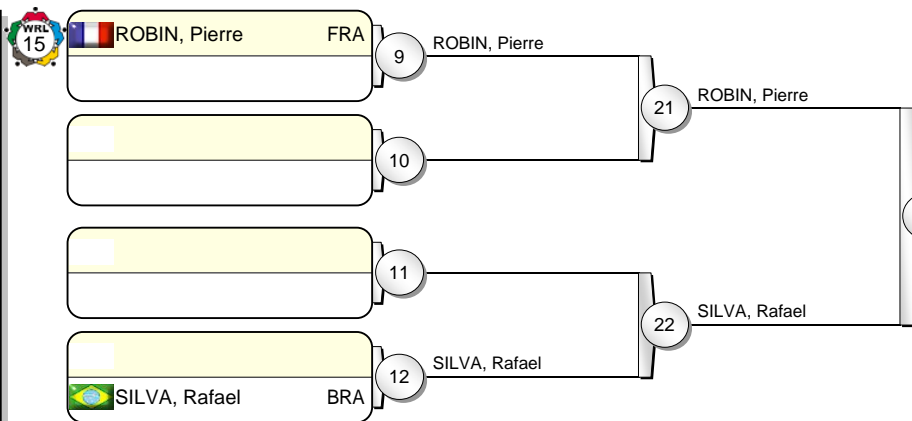

Pool D

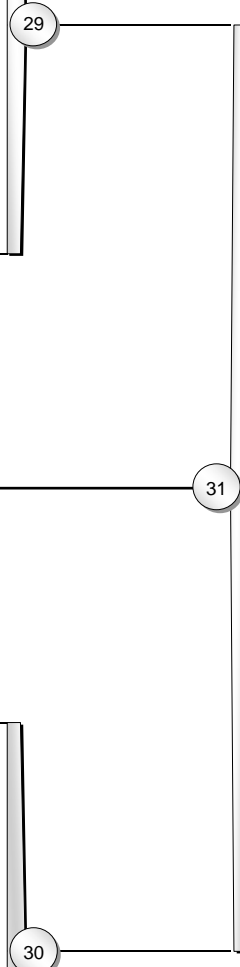
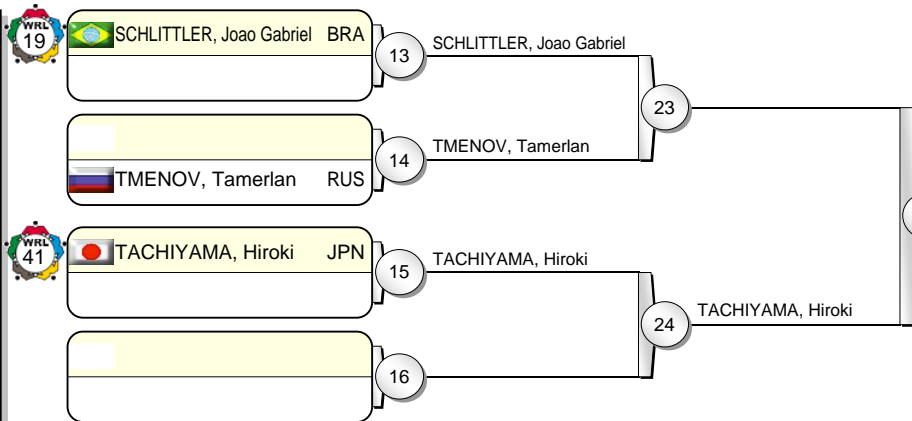

## Results

- 1.
- 2.
- 3.
- 3.
- 5.
- 5.
- 5.





# IJF Grand Slam Rio 2009

(BRA Rio de Janeiro, 04-05 July 2009)

# -48 kg

14 Judoka

Pool A

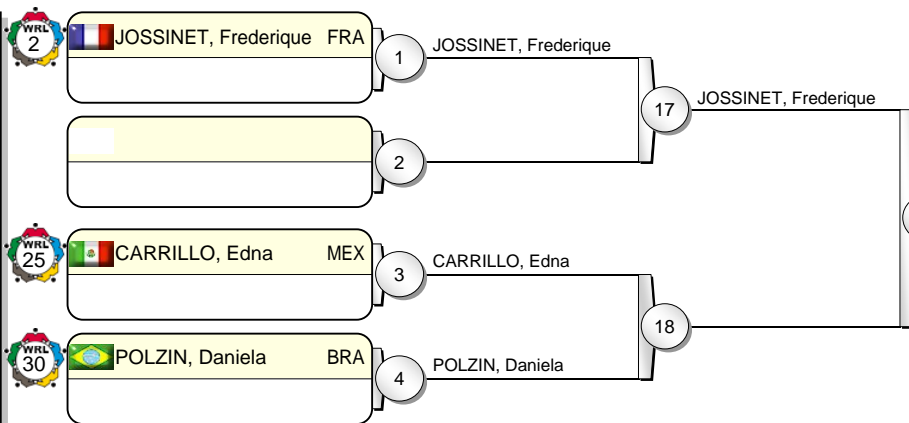

Pool B

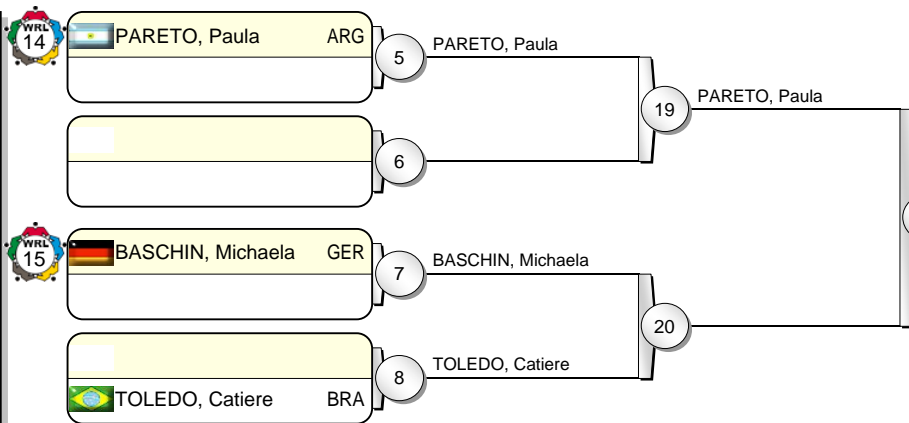

Pool C

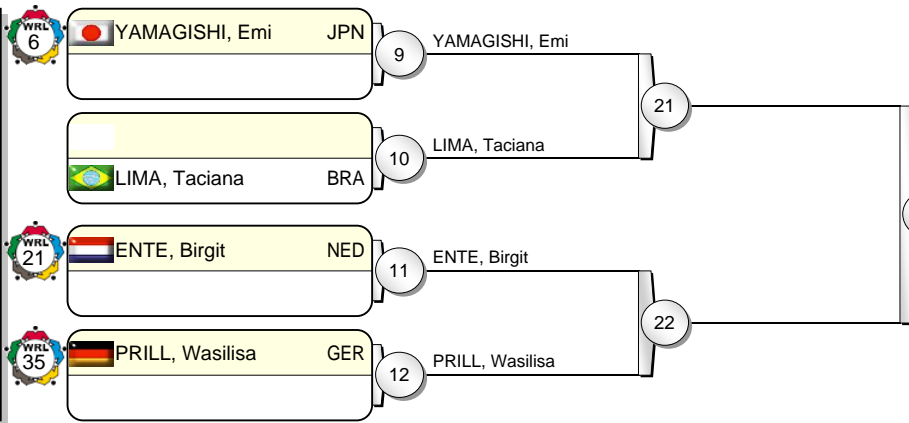

Pool D

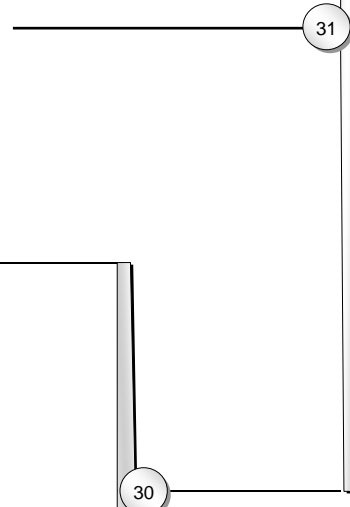
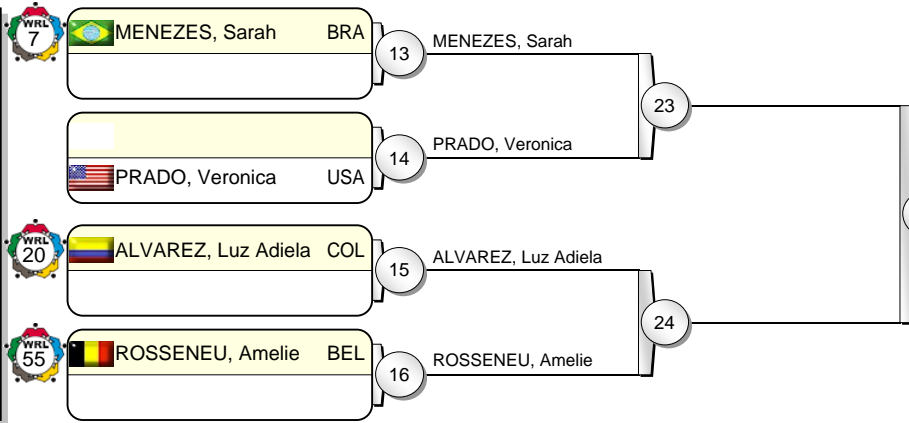

## Results

- 1.
- 2.
- 3.
- 3.
- 5.
- 5.
- 5.







# IJF Grand Slam Rio 2009

(BRA Rio de Janeiro, 04-05 July 2009)

# -52 kg

16 Judoka

Pool A

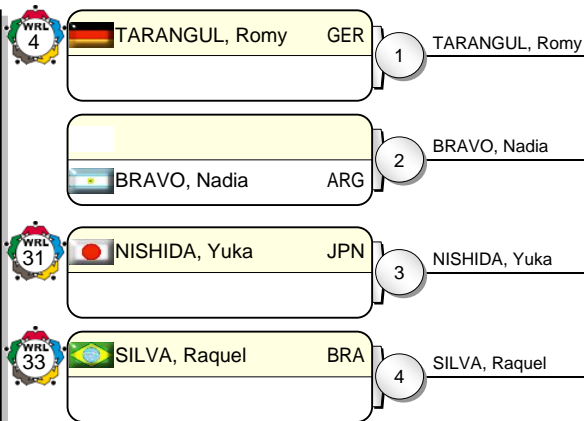

Pool B

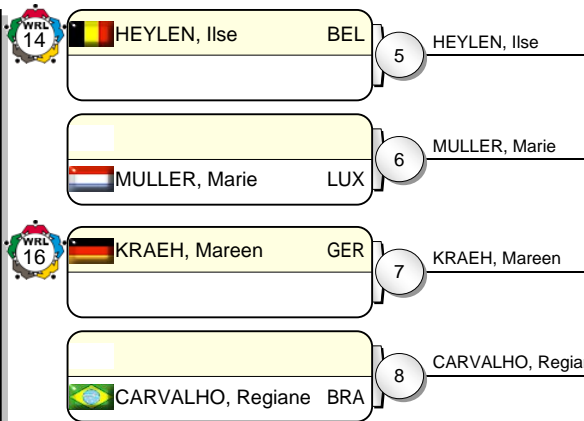

Pool C

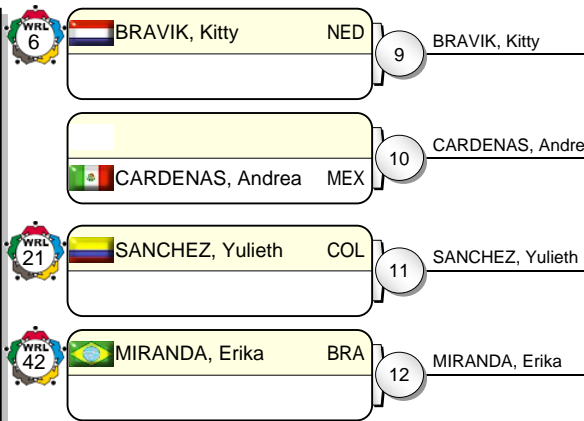

Pool D

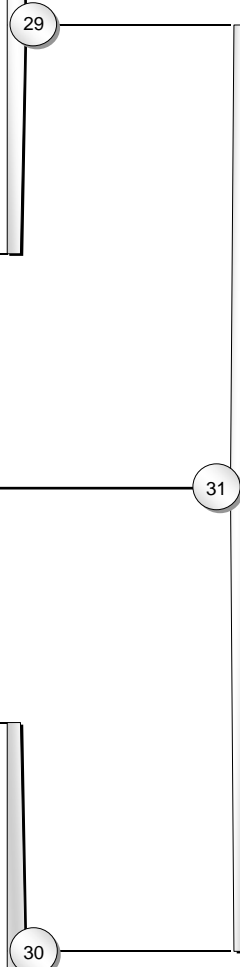
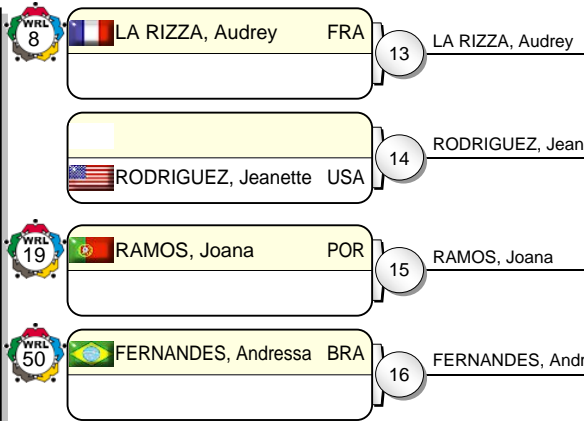

## Results

- 1.
- 2.
- 3.
- 3.
- 5.
- 5.
- 5.





# IJF Grand Slam Rio 2009

(BRA Rio de Janeiro, 04-05 July 2009)

# -57 kg

17 Judoka

Pool A

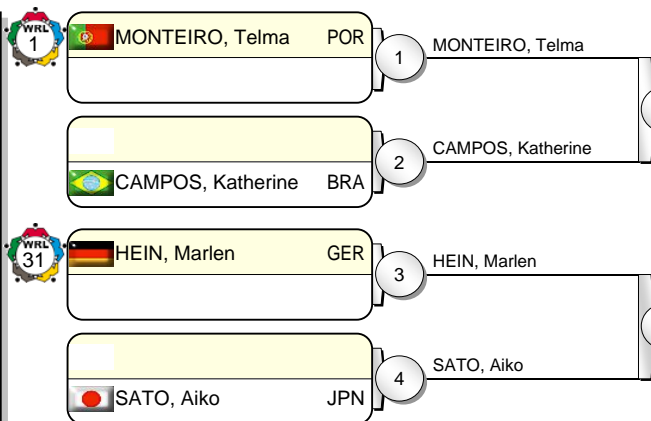

Pool B

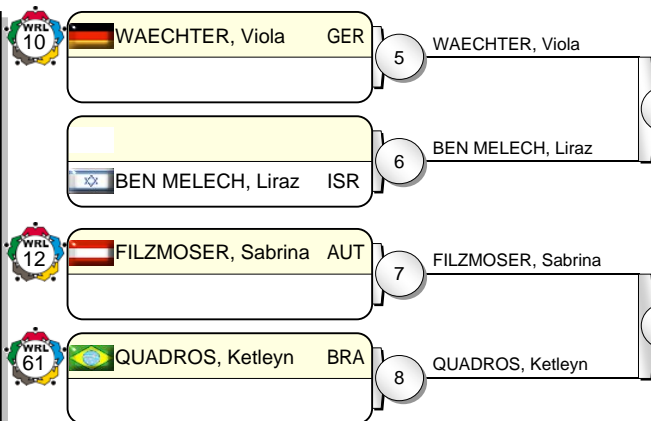

Pool C

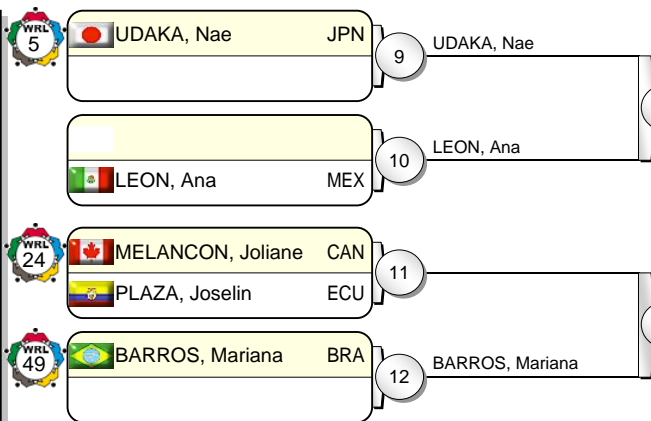

Pool D

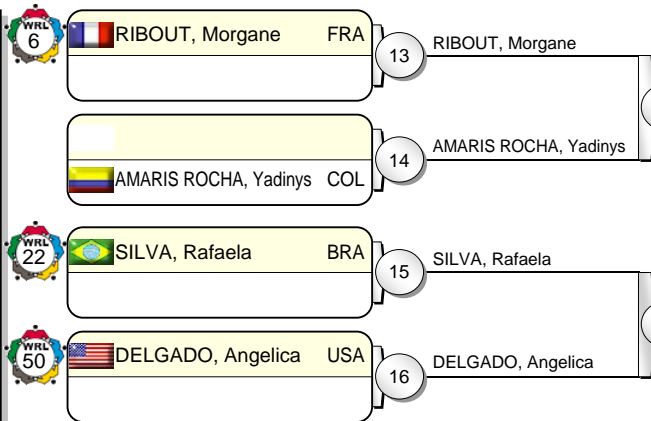

31

30

25

26

27

28

## Results

- 1.
- 2.
- 3.
- 3.
- 5.
- 5.
- 5.





# IJF Grand Slam Rio 2009

(BRA Rio de Janeiro, 04-05 July 2009)

# -63 kg

16 Judoka

Pool A

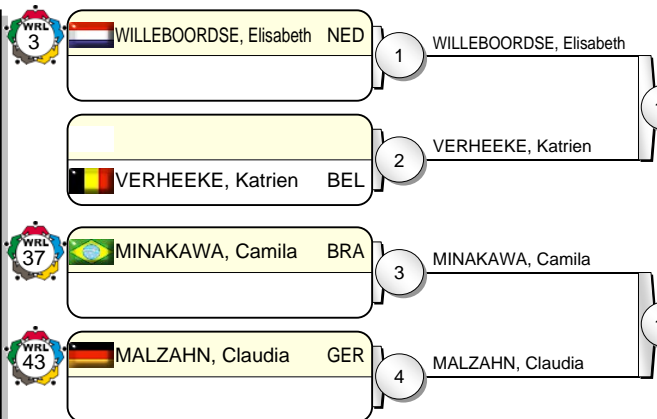

Pool B

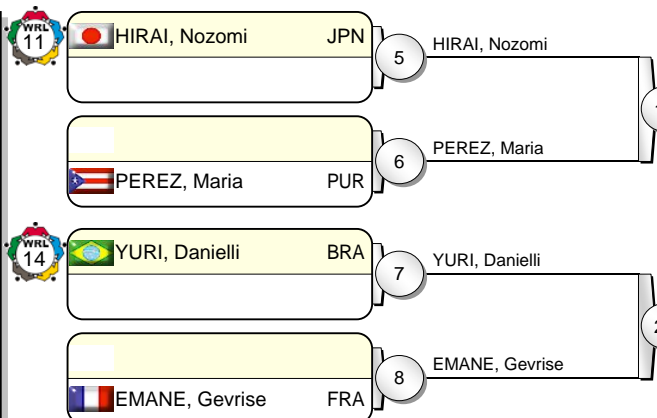

Pool C

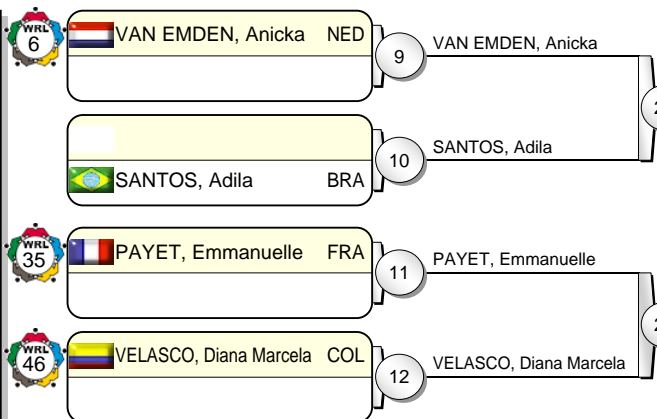

Pool D

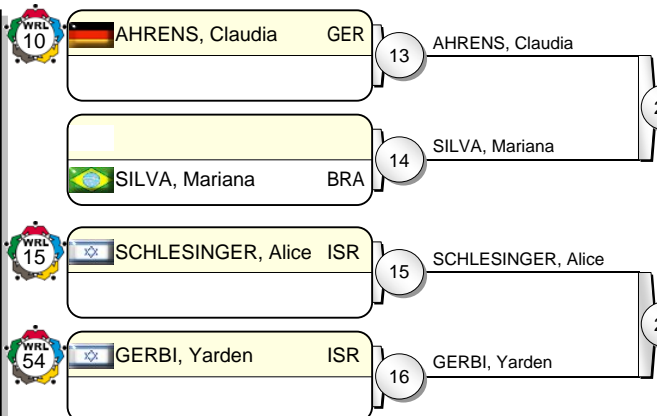

## Results

- 1.
- 2.
- 3.
- 3.
- 5.
- 5.
- 5.





# IJF Grand Slam Rio 2009

(BRA Rio de Janeiro, 04-05 July 2009)

# -70 kg

13 Judoka

Pool A

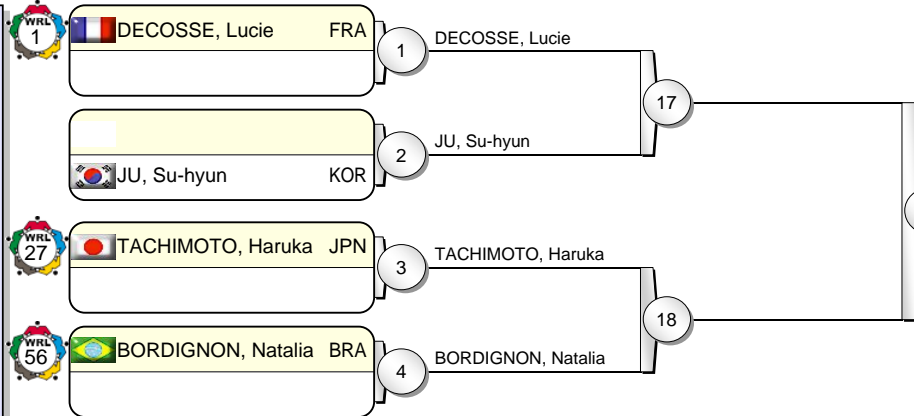

Pool B

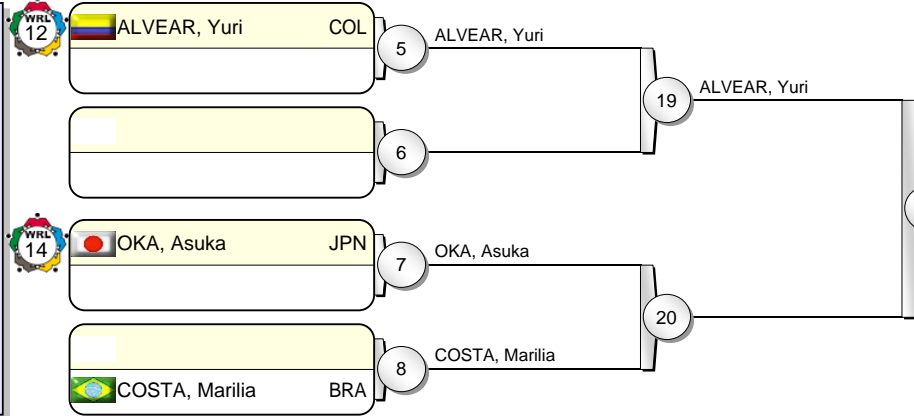

Pool C

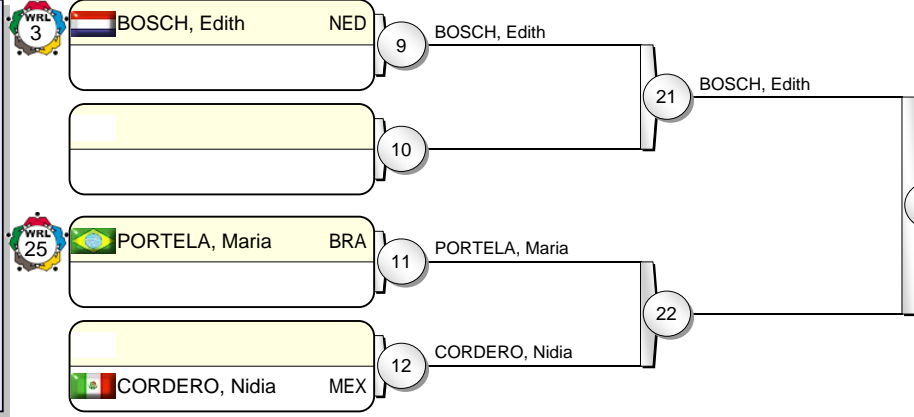

Pool D

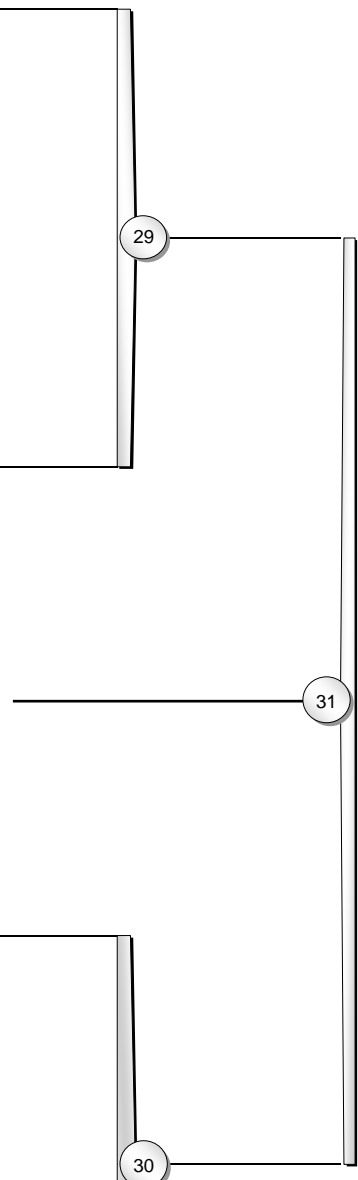
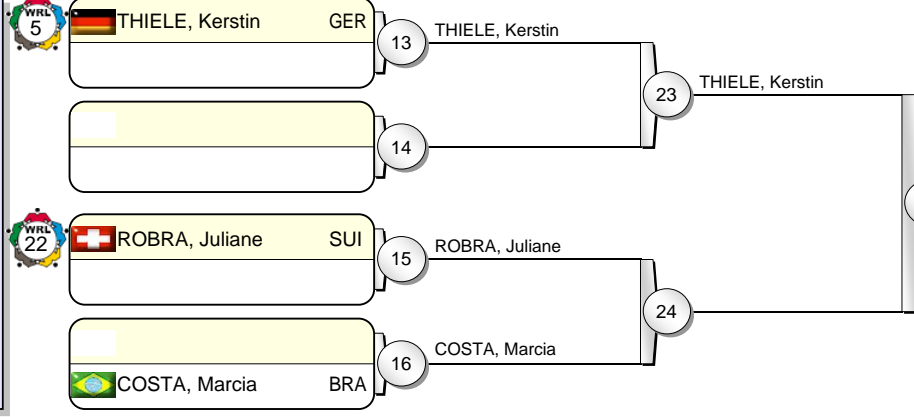

## Results

- 1.
- 2.
- 3.
- 3.
- 5.
- 5.
- 5.





# IJF Grand Slam Rio 2009

(BRA Rio de Janeiro, 04-05 July 2009)

# -78 kg

15 Judoka

Pool A

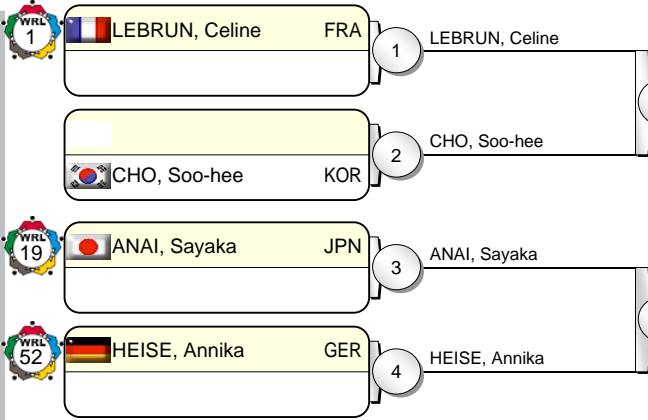

Pool B

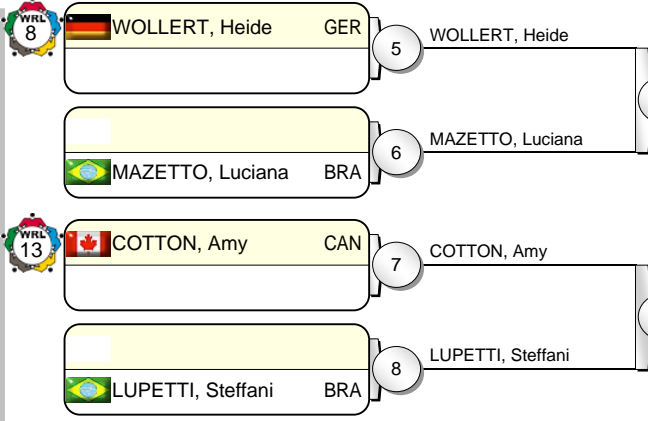

Pool C

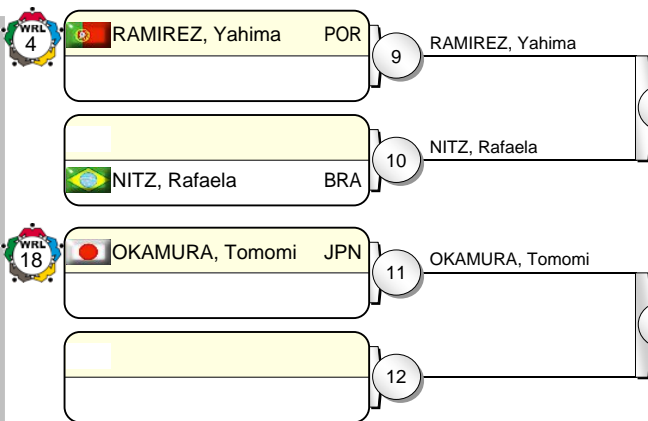

Pool D

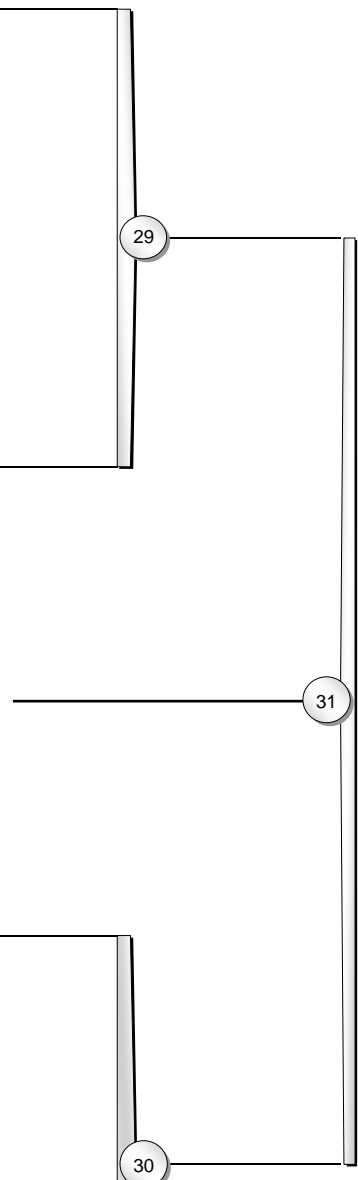
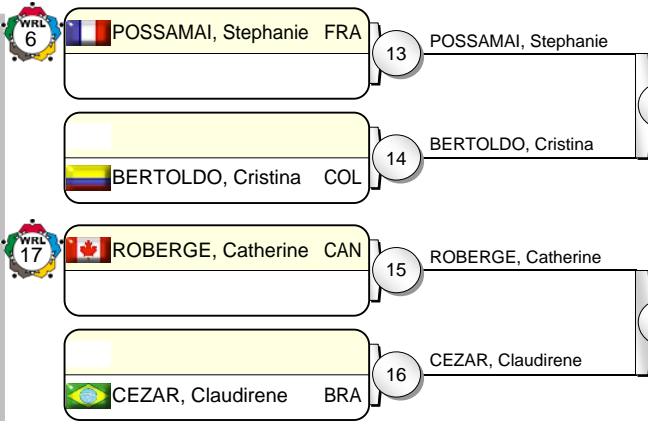

## Results

- 1.
- 2.
- 3.
- 3.
- 5.
- 5.
- 5.





# IJF Grand Slam Rio 2009

(BRA Rio de Janeiro, 04-05 July 2009)

# +78 kg

9 Judoka

Pool A

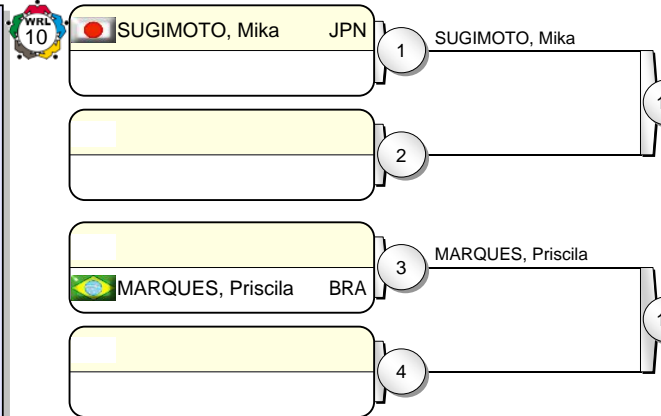

Pool B

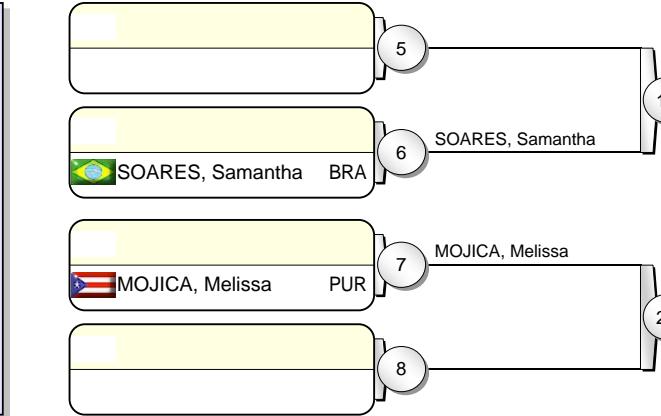

Pool C

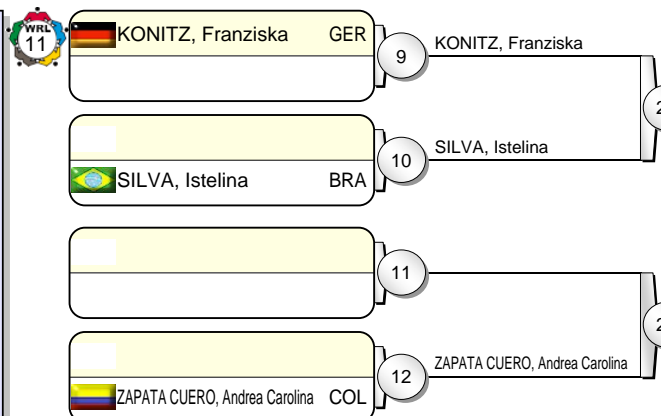

Pool D

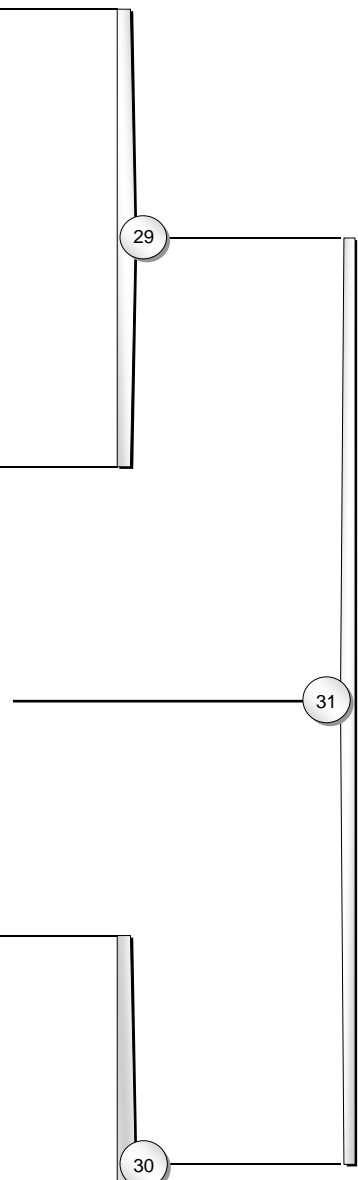
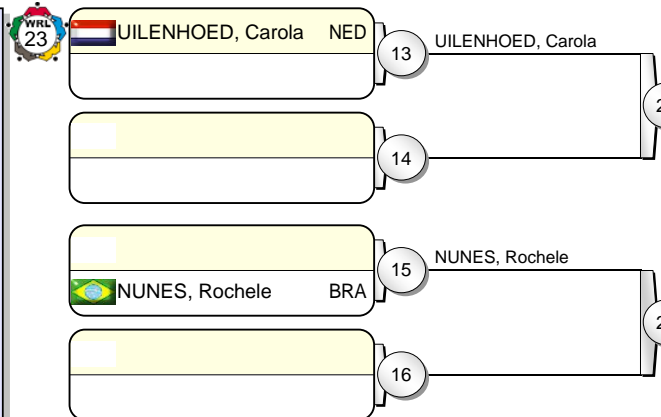

## Results

- 1.
- 2.
- 3.
- 3.
- 5.
- 5.
- 5.

